

**SPECIFICATION
FOR
LCD Module**

Customer P/N:

Santek P/N: ST0430I5WY-RSLW-F

DOC. Revision: RS01

Customer Approval:

--

	SIGNATURE	DATE
PREPARED BY	Vivian Huang	2017-11-15
CHECKED BY	Tom Liao	2017-11-15
APPROVED BY	Natty Lee	2017-Nov-28

Document Revision History

Version	Revise Date	Description	Changed by
RS01	2017.11.15	Initial release	Vivian Huang

Santek / CONFIDENTIAL

Table of Contents

1. General Specifications4

2. Pin Assignment5

 2.1. TFT LCD Panel Driving Section.....5

 2.2. Touch Screen Panel Section.....7

3. Operation Specifications.....8

 3.1. Absolute Maximum Ratings8

 3.2. Typical operation conditions9

 3.3. Backlight Driving Conditions9

 3.4. Power Sequence10

 3.5. Timing Characteristics11

 3.5.1. Timing Conditions11

 3.5.2. Timing Diagram12

4. Touch Screen Panel Specifications13

 4.1. Electrical Characteristics13

 4.2. Mechanical & Reliability Characteristics14

 4.3. Linearity Definition15

 4.4. Housing design guide16

5. Optical Specifications17

6. Reliability Test Items21

7. General Precautions22

 7.1. Safety22

 7.2. Handling22

 7.3. Static Electricity.....22

 7.4. Storage22

 7.5. Cleaning22

8. Mechanical Drawing23

9. Package Drawing24

 9.1. Packaging Material Table.....24

 9.2. Packaging Quantity.....24

 9.3. Packaging Drawing.....25

1. General Specifications

No.	Item	Specification	Remark
1	LCD size	4.3 inch(Diagonal)	
2	Driver element	a-Si TFT active matrix	
3	Resolution	480 × 3 (RGB) × 272	
4	Display mode	Normally White, Transmissive	
5	Dot pitch	0.066(W) × 0.198(H) mm	
6	Active area	95.04(W) × 53.856(H) mm	
7	Module size	105.5(W) × 67.2(H) × 4.05(D) mm	Note 1
8	Surface treatment	Anti-Glare	
9	Color arrangement	RGB-stripe	
10	Interface	Digital	
11	Backlight Power consumption	0.558 W(Typ.)	
12	Panel Power consumption	0.056 W (Typ.)	
13	Weight	59 g (Typ.)	

Note 1: Refer to Mechanical Drawing.

2. Pin Assignment

2.1. TFT LCD Panel Driving Section

FPC Connector is used for the module electronics interface. The recommended model is “FH19SC-40S-0.5SH” manufactured by HIROSE.

Pin No.	Symbol	I/O	Function	Remark
1	V _{LED-}	P	Power for LED backlight cathode	
2	V _{LED+}	P	Power for LED backlight anode	
3	GND	P	Power ground	
4	V _{DD}	P	Power voltage	
5	R0	I	Red data (LSB)	
6	R1	I	Red data	
7	R2	I	Red data	
8	R3	I	Red data	
9	R4	I	Red data	
10	R5	I	Red data	
11	R6	I	Red data	
12	R7	I	Red data (MSB)	
13	G0	I	Green data (LSB)	
14	G1	I	Green data	
15	G2	I	Green data	
16	G3	I	Green data	
17	G4	I	Green data	
18	G5	I	Green data	
19	G6	I	Green data	
20	G7	I	Green data (MSB)	

21	B0	I	Blue data (LSB)	
22	B1	I	Blue data	
23	B2	I	Blue data	
24	B3	I	Blue data	
25	B4	I	Blue data	
26	B5	I	Blue data	
27	B6	I	Blue data	
28	B7	I	Blue data (MSB)	
29	GND	P	Power ground	
30	CLK	I	Pixel clock	
31	DISP	I	Display on/off	
32	NC	-	No connection	
33	NC	-	No connection	
34	DE	I	Data Enable	
35	NC	-	No connection	
36	GND	P	Power ground	
37	X1	I/O	Right electrode – differential analog	
38	Y1	I/O	Bottom electrode – differential analog	
39	X2	I/O	Left electrode – differential analog	
40	Y2	I/O	Top electrode – differential analog	

I: input, O: output, P: Power

2.2. Touch Screen Panel Section

Pin No.	Symbol	I/O	Function	Remark
1	X1	Right	Right electrode – differential analog	
2	Y1	Bottom	Bottom electrode – differential analog	
3	X2	Left	Left electrode – differential analog	
4	Y2	Top	Top electrode – differential analog	

Note: Touch Screen Panel Block

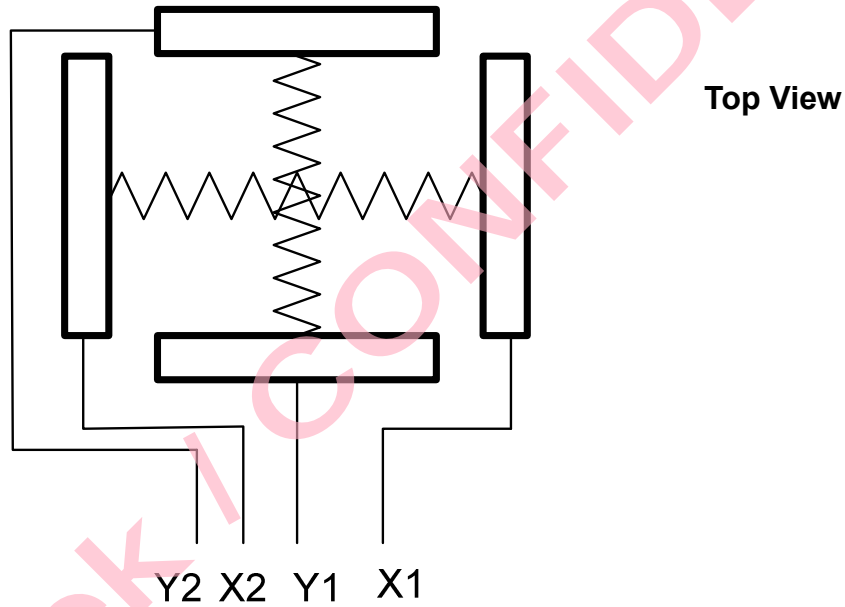

3. Operation Specifications

3.1. Absolute Maximum Ratings

(Note 1)

Item	Symbol	Values		Unit	Remark
		Min.	Max.		
Power voltage	V _{DD}	-0.5	5.0	V	
Input signal voltage	Logic input	-0.5	5.0	V	
Operation temperature	T _{OP}	-20	70	°C	Note 3, 4
Storage temperature	T _{ST}	-30	80	°C	Note 3, 4
LED Reverse Voltage	V _R	-	1.2	V	Each LED Note 2
LED Forward Current	I _F	-	25	mA	Each LED

Note 1: The absolute maximum rating values of this product are not allowed to be exceeded at any times. A module should be used with any of the absolute maximum ratings exceeded, the characteristics of the module may not be recovered, or in an extreme condition, the module may be permanently destroyed.

Note 2: V_R Conditions: Zener Diode 20mA

Note 3: 90% RH Max. (Max wet temp. is 60°C)

Maximum wet-bulb temperature is at 60°C or less. And No condensation (no drops of dew)

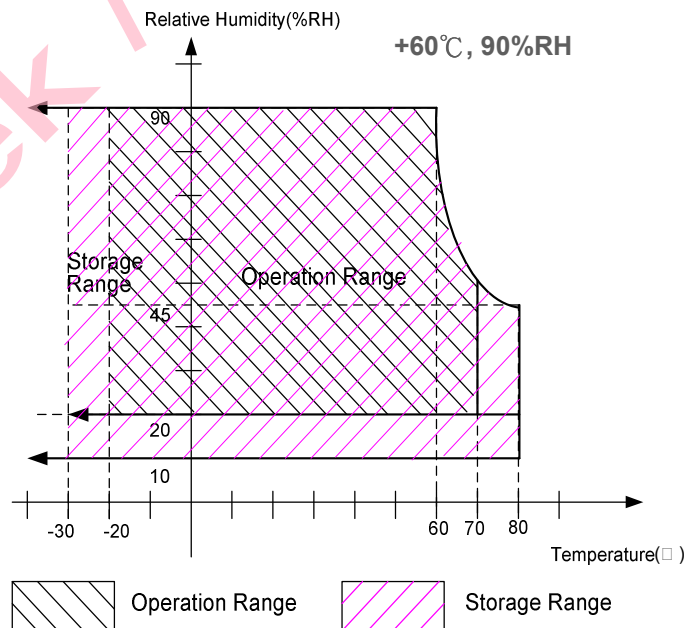

Note 4: In case of temperature below 0°C, the response time of liquid crystal (LC) becomes slower and the color of panel darker than normal one.

3.2. Typical operation conditions

Item	Symbol	Values			Unit	Remark
		Min.	Typ.	Max.		
Power voltage	V_{DD}	3.1	3.3	3.5	V	
Current for Driver	$I_{V_{DD}}$	-	17	25	mA	$V_{DD} = 3.3V$
Input logic high voltage	V_{IH}	$0.8V_{DD}$	-	V_{DD}	V	Note 1
Input logic low voltage	V_{IL}	GND	-	$0.2V_{DD}$	V	

Note1: CLK, DE, R0~ R7, G0~ G7, B0~ B7.

3.3. Backlight Driving Conditions

Item	Symbol	Values			Unit	Remark
		Min.	Typ.	Max.		
Voltage for LED Backlight	V_L	25.2	27.9	31.5	V	Note 2
Current for LED Backlight	I_L	18	20	22	mA	
LED life time	-	20,000	-	-	Hr	Note 1

Note 1: The "LED life time" is defined as the module brightness decrease to 50% original brightness that the ambient temperature is 25°C and $I_L = 20mA$. The LED lifetime could be decreased if operating I_L is larger than 20 mA.

Note 2: The LED Supply Voltage is defined by the number of LED at $T_a = 25^\circ C$ and $I_L = 20mA$.

3.4. Power Sequence

To prevent a latch-up or DC operation of the LCD module, the power on/off sequence should be as the diagram below.

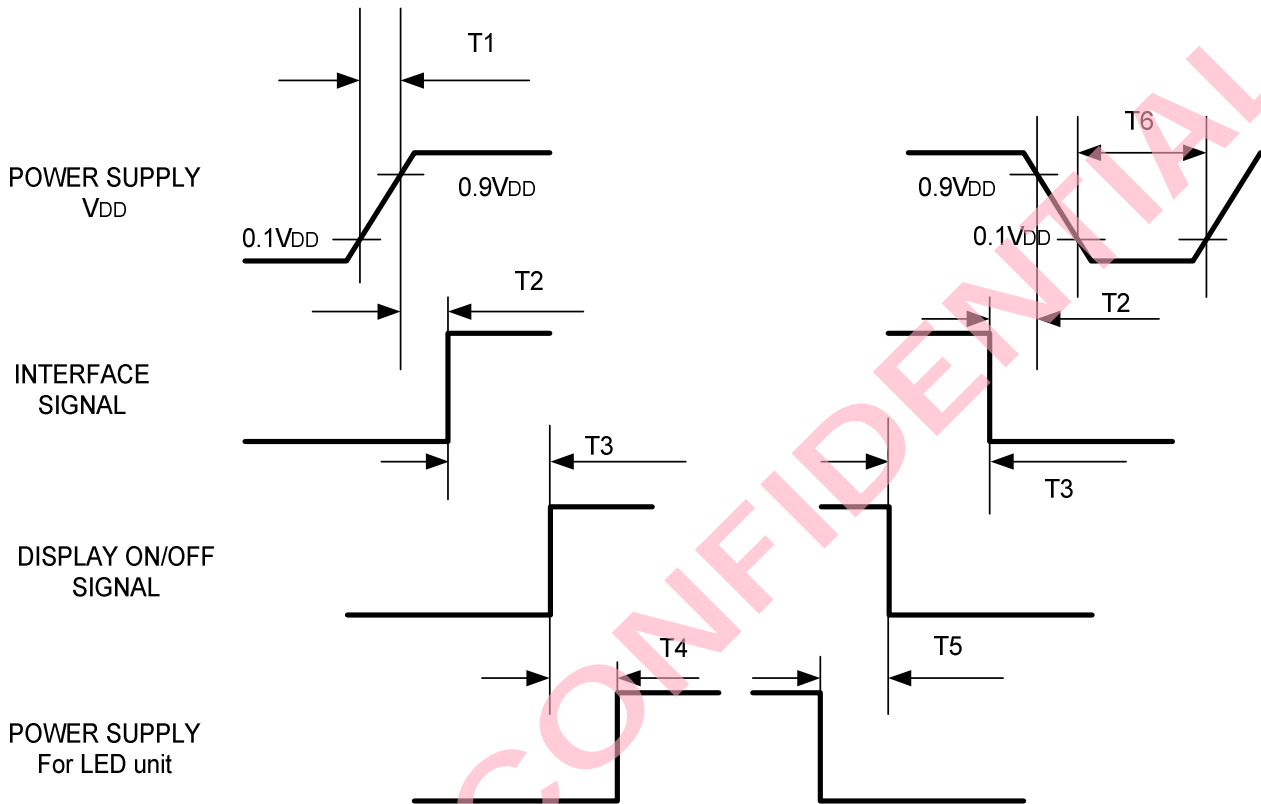

Symbol	Specification	Symbol	Specification
T1	$0 \leq T1 \leq 10 \text{ msec}$	T4	$160 \text{ msec} \leq T4$
T2	$0 \leq T2 \leq 100 \text{ msec}$	T5	$160 \text{ msec} \leq T5$
T3	$0 \leq T3 \leq 200 \text{ msec}$	T6	$1 \text{ msec} \leq T6$

3.5. Timing Characteristics

3.5.1. Timing Conditions

Parallel DE mode RGB input timing table

Parameter	Symbol	Value			Unit
		Min.	Typ.	Max.	
CLK frequency	fclk	7	9	12	MHz
DEV period time	Tv	277	288	400	H
DEV display area	Tvd	272			H
DEV blanking	Tvb	5	16	128	H
DEH period time	Th	520	525	800	CLK
DEH display area	Thd	480			CLK
DEH blanking	Thb	40	45	320	CLK
CLK cycle time	Tclk	83	110	143	ns
Clock width of high level	Tcwh	40	50	60	%
Clock width of low level	Tcwl	40	50	60	%
Clock rising time	t _{rck}		-	9	ns
Clock falling time	t _{fcck}		-	9	ns
Data Setup Time	t _{desu}	10	-	-	ns
Data Hold Time	t _{dahd}	10	-	-	ns
DE Setup Time	t _{desu}	10	-	-	ns
DE Hold Time	t _{dehd}	10	-	-	ns

3.5.2. Timing Diagram

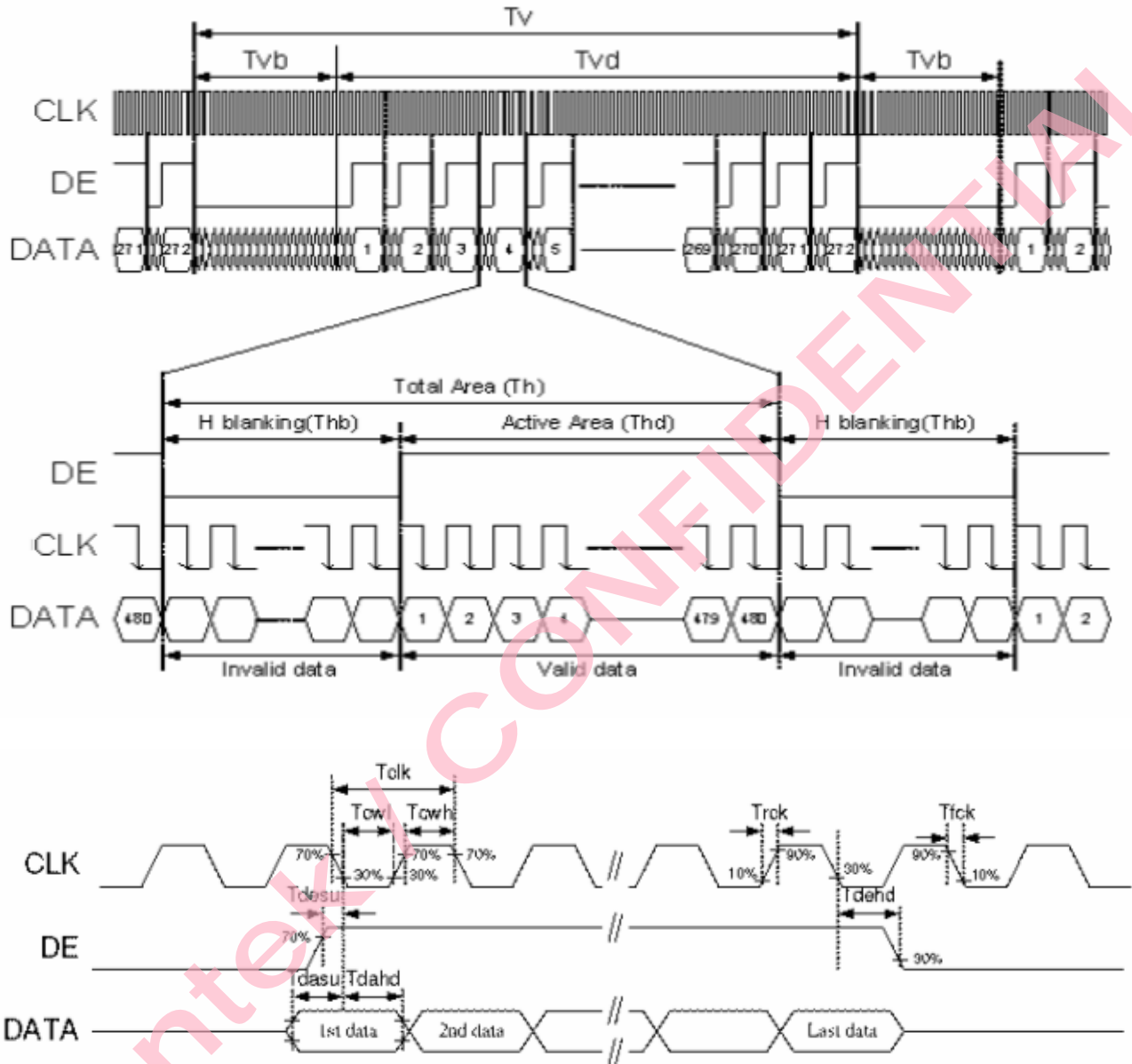

4. Touch Screen Panel Specifications

4.1. Electrical Characteristics

Item	Value			Unit	Remark
	Min.	Typ.	Max.		
Linearity	-1.5	-	1.5	%	Analog X and Y directions
Terminal Resistance	300	-	1500	Ω	X
	100	-	900	Ω	Y
Insulation resistance	25	-	-	M Ω	DC 25V
Voltage	-	5	7	V	DC
Chattering	-	-	10	ms	100k Ω pull-up
Transparency	80	-	-	%	JIS K7105

Note: Avoid operating with hard or sharp material such as a ball point pen or a mechanical pencil except a polyacetal pen (tip R0.8mm or less) or a finger.

4.2. Mechanical & Reliability Characteristics

Item	Value			Unit	Remark
	Min.	Typ.	Max.		
Activation force	80	-	-	gf	Note 1
Durability-surface scratching	Write 100,000	-	-	characters	Note 2
Durability-surface pitting	1,000,000	-	-	touches	Note 3
Surface hardness	3	-	-	H	JIS K5400

Note 1: Activation force test condition

- (1) Input DC 5V on X direction, Drop off Polyacetal Stylus (R0.8), until output voltage stabilize, then get the activation force.
- (2) R8.0mm Silicon rubber for finger Activation force test
- (3) Test point: 9 points

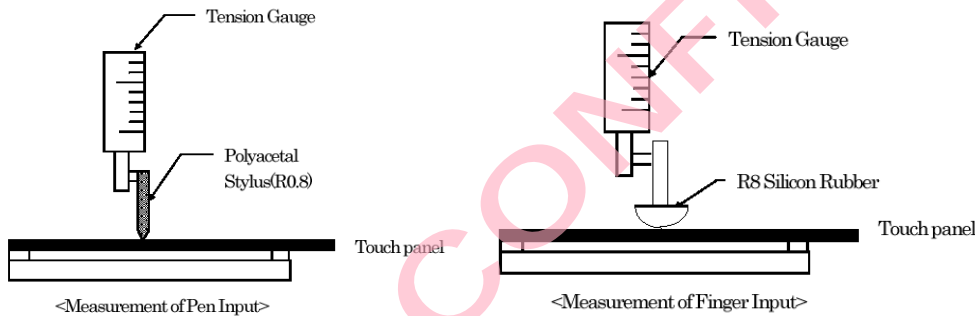

Note 2: Measurement for surface area.

- Scratch 100,000 times straight line on the film with a stylus change every 20,000 times.
- Force: 250gf.
- Speed: 60mm/sec.
- Stylus: R0.8 polyacetal tip.

Note 3: Pit 1,000,000 times on the film with a R0.8 silicon rubber.

- Force: 250gf.
- Speed: 2times/sec.

4.3. Linearity Definition

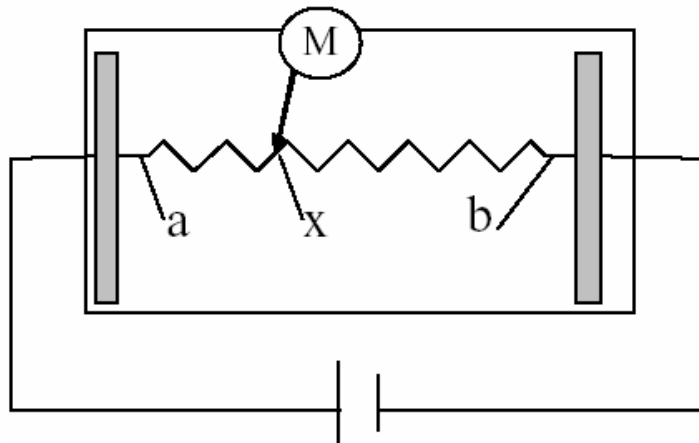

V_a : maximum voltage in the active area of touch panel
 V_b : minimum voltage in the active area of touch panel
 X : random measuring point
 V_{xm} : actual voltage of L_x point
 V_{xi} : theoretical voltage of L_x point

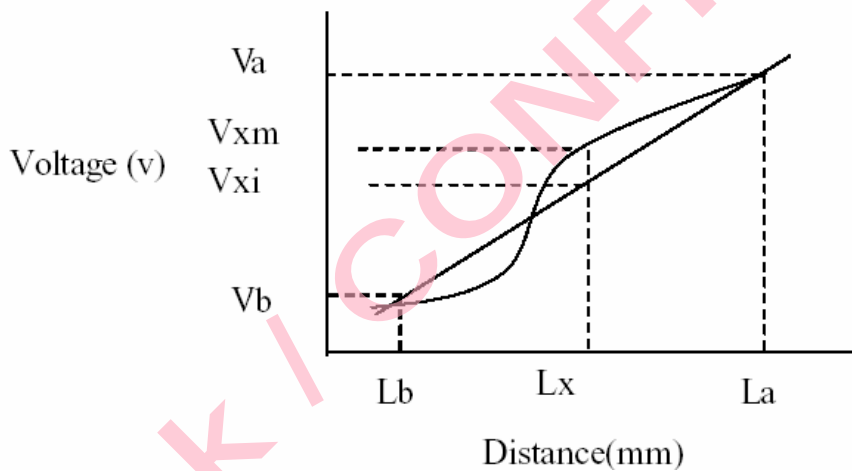

$$\text{Linearity} = \frac{|V_{xi} - V_{xm}|}{(V_a - V_b)} * 100\%$$

Note: Test area is as follows and operation force is 150gf.

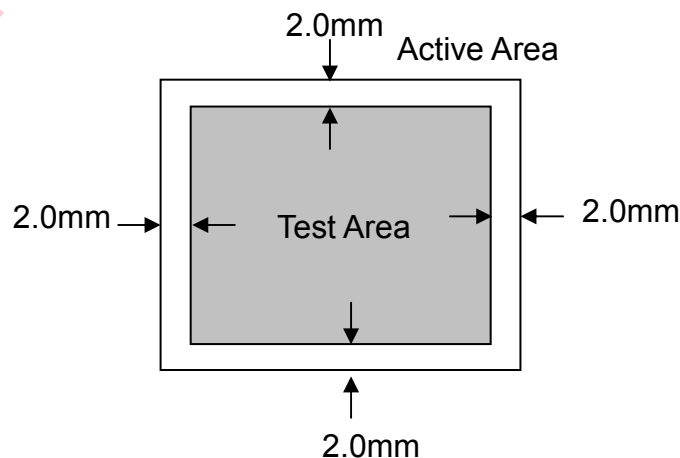

4.4. Housing design guide

Housing design follow as below

- 1) Avoid the design that housing overlap and press on the active area of the LCM
- 2) Give enough gap(over 0.5mm at compressed) between the housing and TSP to protect wrong operating.

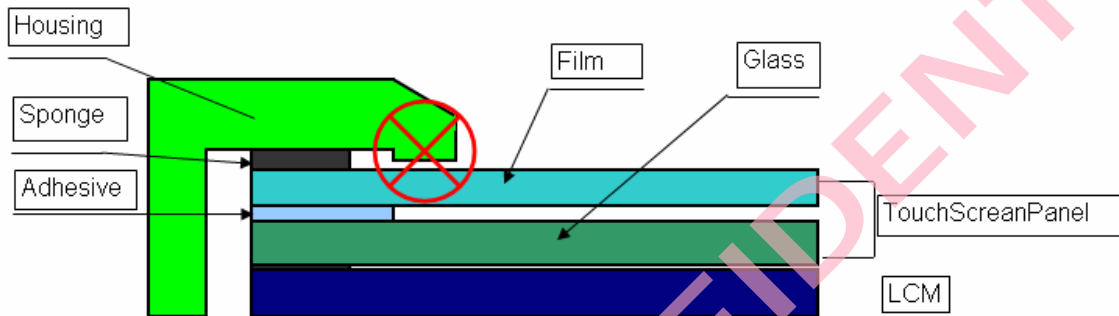

- 3) Use a buffer material(Gasket) between the TSP and housing to protect damage and wrong operating
- 4) Avoid the design that buffer material overlap and press on the inside of TSP view area.

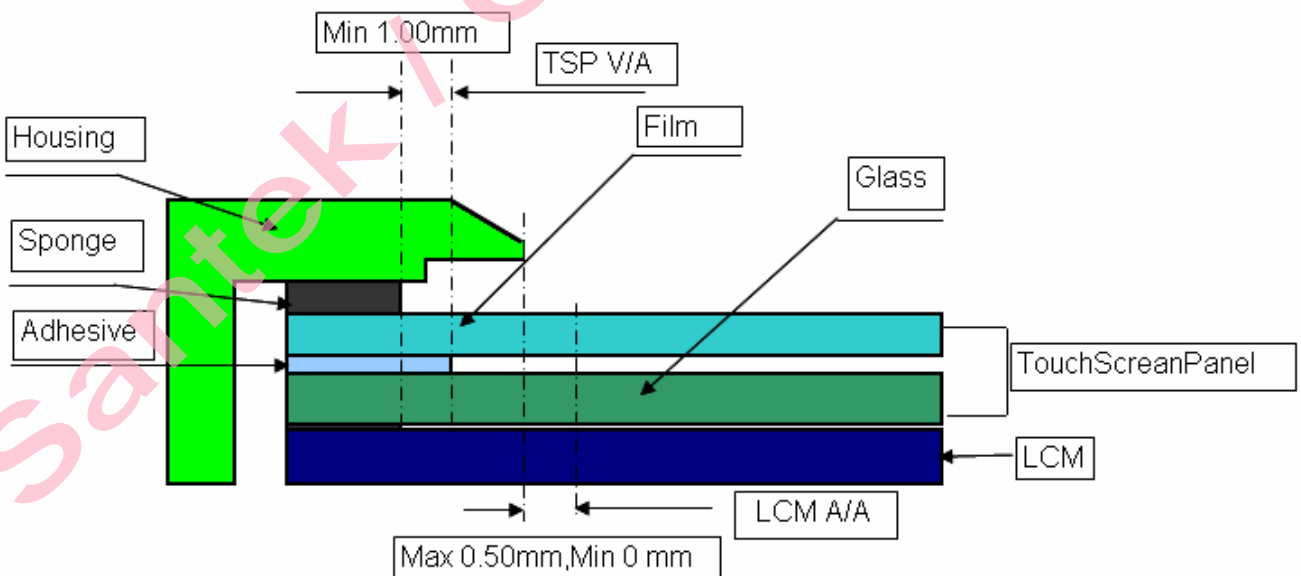

5. Optical Specifications

Item	Symbol	Condition	Values			Unit	Remark
			Min.	Typ.	Max.		
Viewing angle (CR≥ 10)	θ_L	$\Phi=180^\circ$ (9 o'clock)	60	70	-	degree	Note 1 Note 7
	θ_R	$\Phi=0^\circ$ (3 o'clock)	60	70	-		
	θ_T	$\Phi=90^\circ$ (12 o'clock)	40	50	-		
	θ_B	$\Phi=270^\circ$ (6 o'clock)	60	70	-		
Response time	T_{ON}	Normal $\theta=\Phi=0^\circ$	-	10	20	msec	Note 3
	T_{OFF}		-	15	30	msec	Note 3
Contrast ratio	CR		400	500	-	-	Note 4
Color chromaticity	W_X		0.26	0.31	0.36	-	Note 2 Note 5
	W_Y		0.28	0.33	0.38	-	Note 6 Note 7
Luminance	L		350	400	-	cd/m ²	Note 6
Luminance uniformity	Y_U		70	75	-	%	Note 8

Test Conditions:

1. $V_{DD}=3.3V$, $I_L=20mA$ (Backlight current), the ambient temperature is 25°C.
2. The test systems refer to Note 2.

Note 1: Definition of viewing angle range

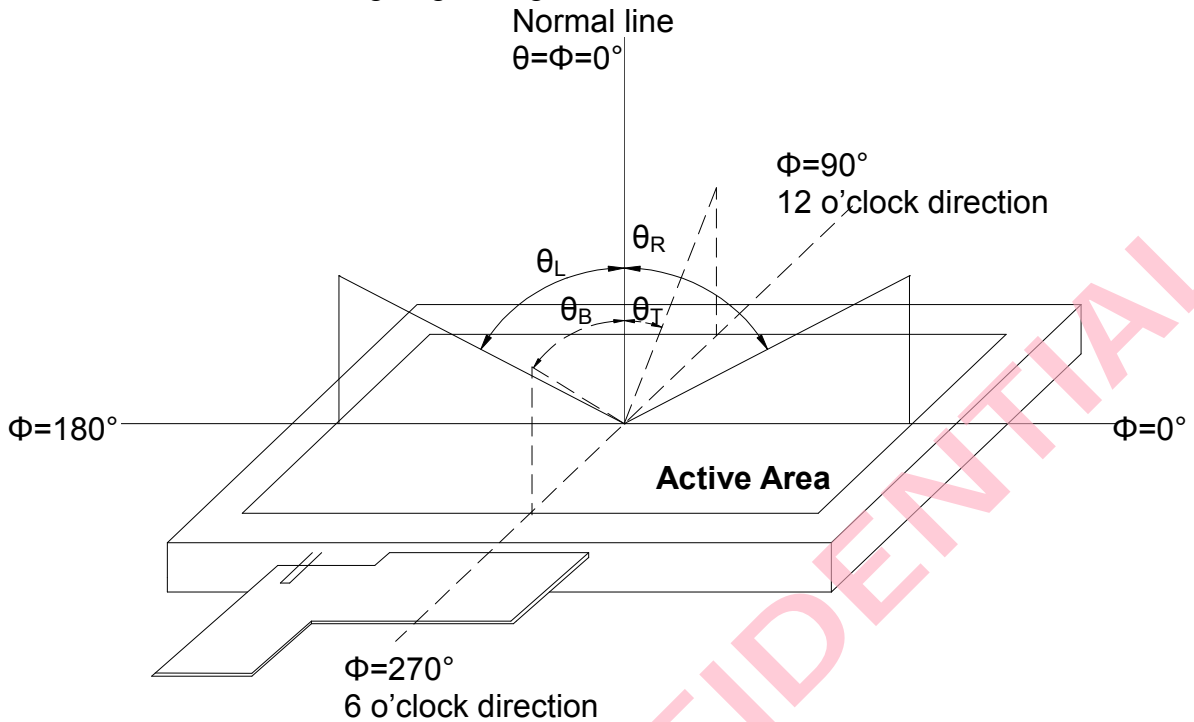

Fig. 4-1 Definition of viewing angle

Note 2: Definition of optical measurement system.

The optical characteristics should be measured in dark room. After 30 minutes operation, the optical properties are measured at the center point of the LCD screen. (Response time is measured by Photo detector TOPCON BM-7, other items are measured by BM-5A/Field of view: 1° /Height: 500mm.)

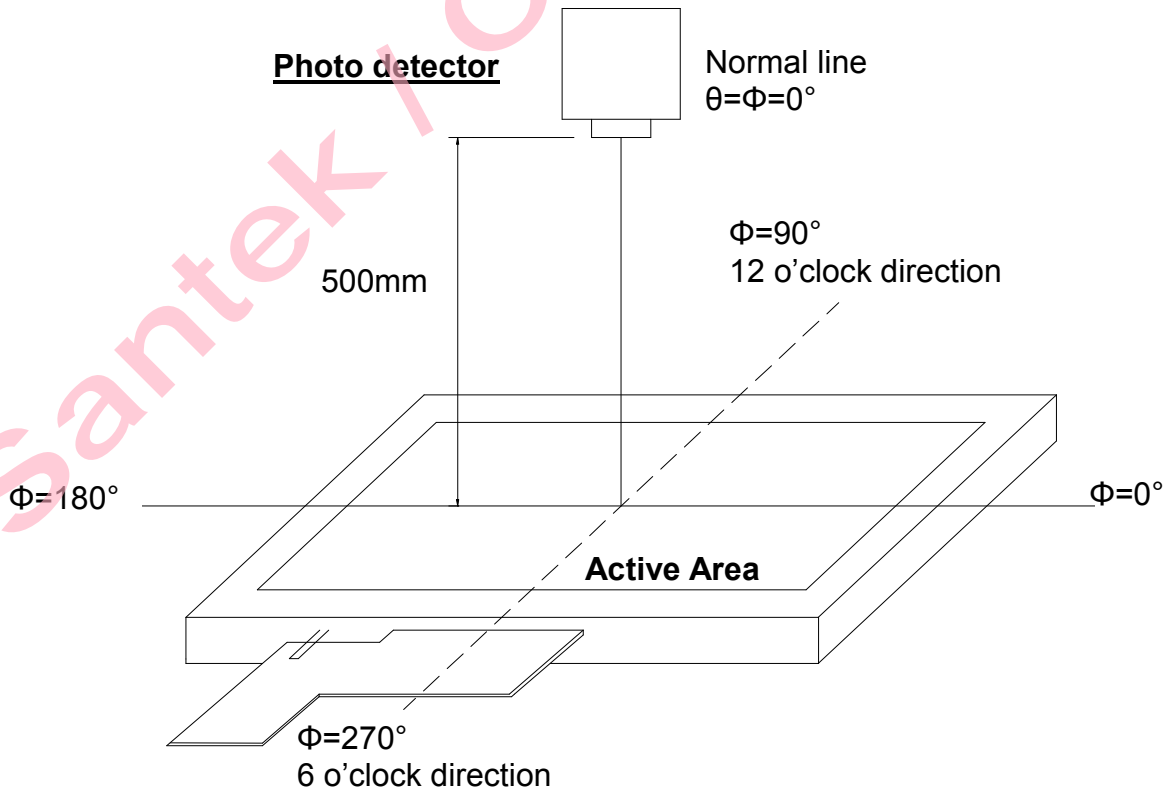

Fig. 4-2 Optical measurement system setup

Note 3: Definition of Response time

The response time is defined as the LCD optical switching time interval between “White” state and “Black” state. Rise time (T_{ON}) is the time between photo detector output intensity changed from 90% to 10%. And fall time (T_{OFF}) is the time between photo detector output intensity changed from 10% to 90%.

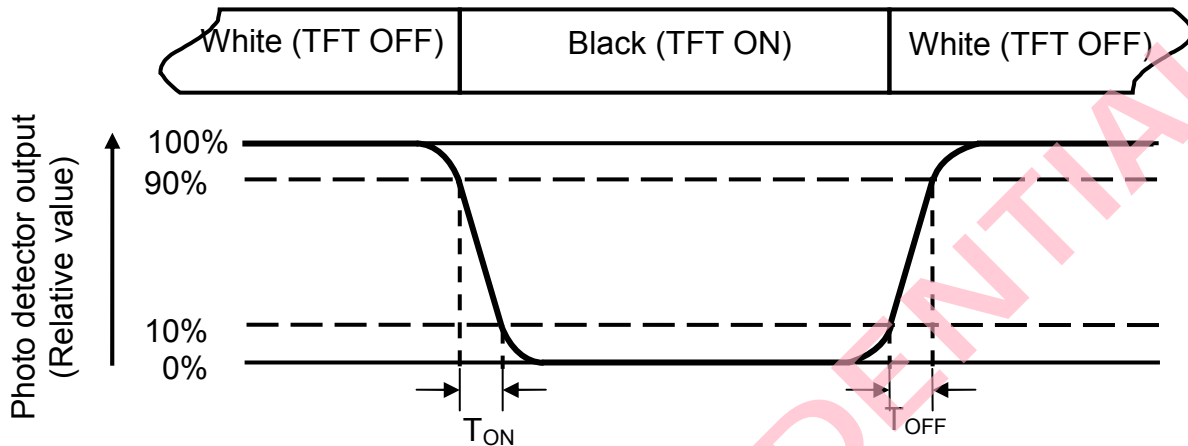

Fig. 4-3 Definition of response time

Note 4: Definition of contrast ratio

$$\text{Contrast ratio (CR)} = \frac{\text{Luminance measured when LCD on the "White" state}}{\text{Luminance measured when LCD on the "Black" state}}$$

Note 5: Definition of color chromaticity (CIE1931)

Color coordinates measured at center point of LCD.

Note 6: All input terminals LCD panel must be ground while measuring the center area of the panel. The LED driving condition is $I_L=20\text{mA}$.

Note 7: The values shall be measured without Touch Screen Panel.

Note 8: Definition of Luminance Uniformity

Active area is divided into 9 measuring areas (Refer to Fig. 4-4).Every measuring point is placed at the center of each measuring area.

$$\text{Luminance Uniformity (Yu)} = \frac{B_{min}}{B_{max}}$$

L-----Active area length W----- Active area width

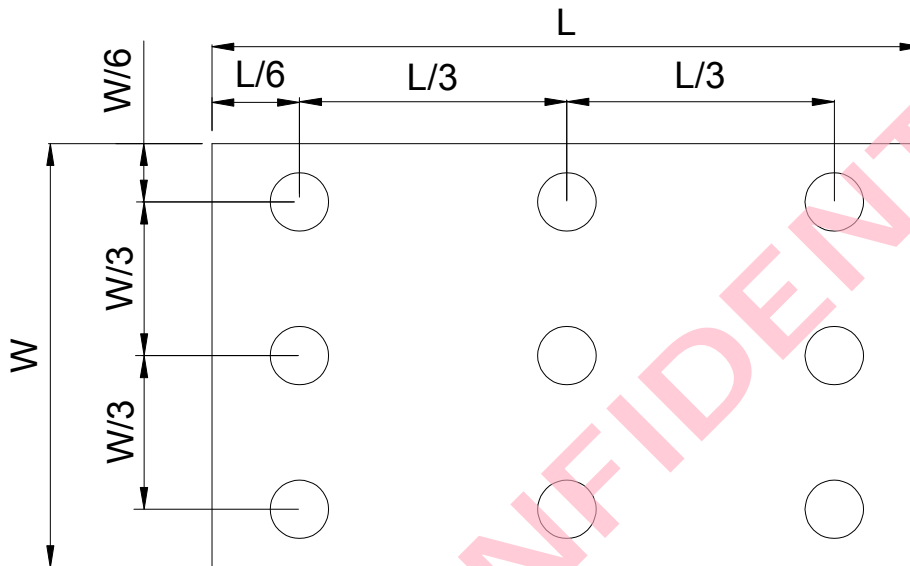

Fig. 4-4 Definition of measuring points

B_{max}: The measured maximum luminance of all measurement position.

B_{min}: The measured minimum luminance of all measurement position.

7. General Precautions

7.1. Safety

Liquid crystal is poisonous. Do not put it in your mouth. If liquid crystal touches your skin or clothes, wash it off immediately by using soap and water.

7.2. Handling

1. The LCD panel is plate glass. Do not subject the panel to mechanical shock or to excessive force on its surface.
2. The polarizer attached to the display is easily damaged. Please handle it carefully to avoid scratch or other damages.
3. To avoid contamination on the display surface, do not touch the module surface with bare hands.
4. Keep a space so that the LCD panels do not touch other components.
5. Put cover board such as acrylic board on the surface of LCD panel to protect panel from damages.
6. Transparent electrodes may be disconnected if you use the LCD panel under environmental conditions where the condensation of dew occurs.
7. Do not leave module in direct sunlight to avoid malfunction of the ICs.

7.3. Static Electricity

1. Be sure to ground module before turning on power or operating module.
2. Do not apply voltage which exceeds the absolute maximum rating value.

7.4. Storage

1. Store the module in a dark room where must keep at $25\pm 10^{\circ}\text{C}$ and 65%RH or less.
2. Do not store the module in surroundings containing organic solvent or corrosive gas.
3. Store the module in an anti-electrostatic container or bag.

7.5. Cleaning

1. Do not wipe the polarizer with dry cloth. It might cause scratch.
2. Only use a soft sloth with IPA to wipe the polarizer, other chemicals might permanent damage to the polarizer.

8. Mechanical Drawing

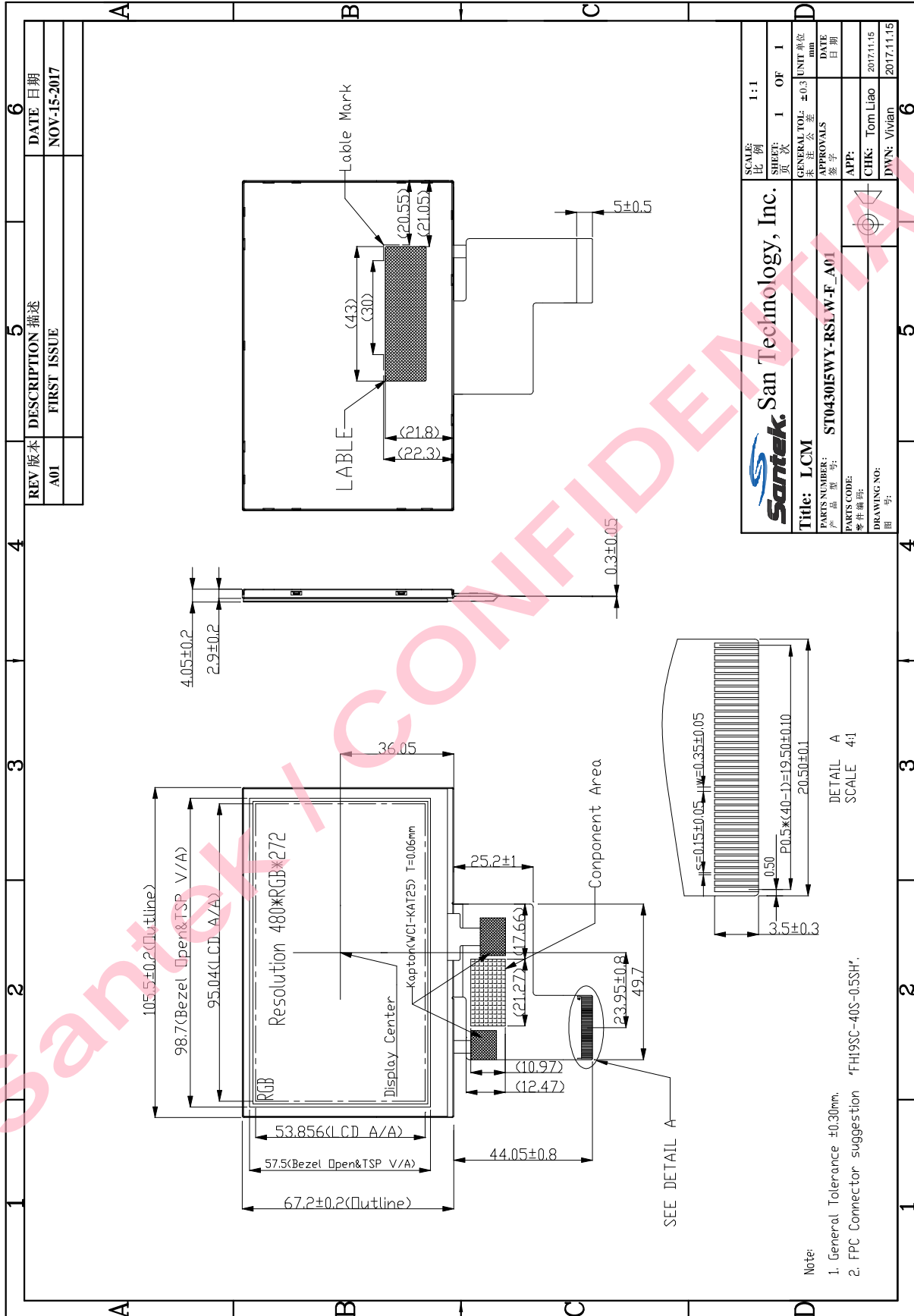

9. Package Drawing

9.1. Packaging Material Table

No.	Item	Model (Material)	Dimensions (mm)	Unit Weight (kg)	Quantity (pcs)	Remark
1	LCM Module	ST0430I5WY-RSLW-F	105.5 × 67.2 × 4.05	0.059	160	
2	Partition	BC Corrugated paper	512 × 349 × 106	1.102	2	
3	Corrugated Bar	BC Corrugated paper	349 × 173	0.030	8	
4	Dust-Proof Bag	PE	700 × 530	0.060	1	
5	Corrugated Board-1	BC Corrugated Paper	510 × 343	0.130	2	
6	Corrugated Board-2	BC Corrugated Paper	1152 × 512	0.260	1	
7	A/S Bag	PE	132 × 117	0.002	160	
8	Carton	Corrugated paper	530 × 355 × 255	1.100	1	
9	Total weight	13.884±5%KG				

9.2. Packaging Quantity

(1) LCM quantity per Partition: 2Rows x 40quantity per Row = 80 pcs

(2) Total LCM quantity in Carton: 2 layer x 80 pcs per Partition = 160 pcs

9.3. Packaging Drawing

